

HERZ - Sanitary Water Manifold

Data sheet 2 8530 0X, Issue 0325

☑ Dimensions

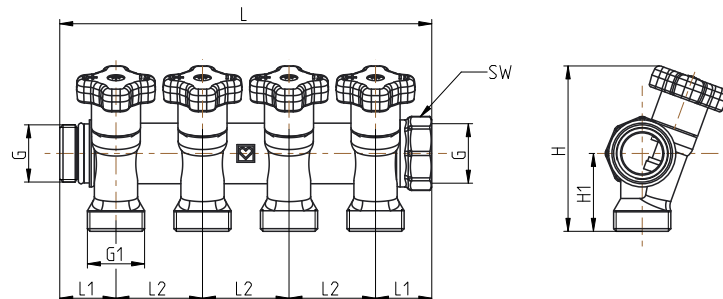

Art. Nr.	DN	Circuits	PN [bar]	G [in]	G1 [in]	L1 [mm]	L2 [mm]	H1 [mm]	H [mm]	L [mm]	Sw [mm]
2 8530 02	20	2	10	3/4"	3/4" eurocone	26	40	36	76.5	92	32
2 8530 03	20	3	10	3/4"	3/4" eurocone	26	40	36	76.5	132	32
2 8530 04	20	4	10	3/4"	3/4" eurocone	26	40	36	76.5	172	32

*4- circuit manifold is shown on the drawing above

☑ Material and construction

Body:	forged brass in compliance with the UBA / 4MS lists, CW617N
Spindle:	machined brass in compliance with the UBA / 4MS lists, CW614N
Handles:	PA-6
Spindle seals:	EPDM
O-ring seal:	EPDM
External thread connectors:	acc. to ISO 228
Internal thread connectors:	acc. to ISO 228

☑ Operating data:

Max. operating pressure:	10 bar
Min. operating temperature:	0 °C (water 0,5 °C)
Max. operating temperature:	110 °C
Medium:	Sanitary water or water for heating systems

When the manifold is used in heating systems, the heating water has to have quality according to ÖNORM H5195 or VDI-Standard 2035. The use of ethylene or propylene glycol in a mixing ratio 25- 50% is allowed. Please refer to manufacturers documentation when using ethylene glycol products for frost and corrosion protection. Please note that EPDM gaskets will be affected by Mineral oils lubricants and thus lead to failure of the EPDM seals in the valves that use EPDM seals. HERZ - Sanitary water manifolds is not suitable for usage of aggressive medium (such as: acids, alkalis, combustible and explosive gases;) because it can destroy sealing components.

☑ Description of HERZ - Sanitary water manifolds

Sanitary water manifolds systems are high quality products that are assembled and pressure tested during the manufacturing process under constant quality control.

Advantages of HERZ - Sanitary water manifold systems are:

- All pipes centralized in one place - EASY CONTROL FOR THE USER
- Quick modular connections between manifolds due to easy sealing design
- The position of the handle makes it easier to access
- Fewer fittings means less chance of leakage - direct connection to the sanitary tap, sink, baths, etc.
- Reduced installation time of between 30%- 40% due to fewer fittings required
- Each individual circuit, whether it is hot or cold, can be marked with stickers during installation, allowing easy identification of which isolating tap to close
- Manifolds can be installed in a convenient location for easy access, meaning less disruption to the building occupiers and ease of repair
- Easy to use and maintain
- Reliable design and long service life
- Permanent quality control of production in our own factories
- Easy installation
- Compatibility with other HERZ products

Field of application

HERZ - Sanitary water manifolds can be used everywhere you need to distribute hot or cold water from the source to the consumer (washing machines, baths, sinks, etc.). The manifolds can be plugged on one side with a male 3/4" plug. Input of the manifold is male threaded G3/4". We recommend to use HERZ straight or angle isolation valves. Each outlet is possible to connect with a female G3/4" adapter for HERZ PIPEFIX.

Left side connection - Straight valves

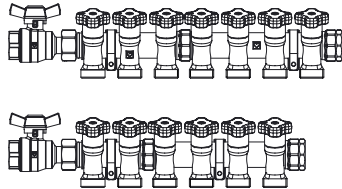

Left side connection - Angle valves

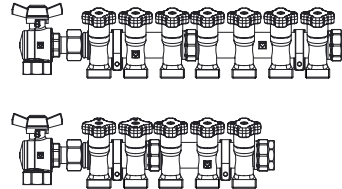

Right side connection - Straight valves

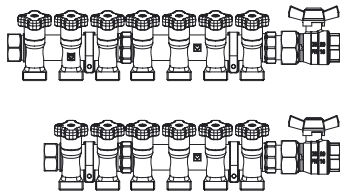

HERZ Pipefix

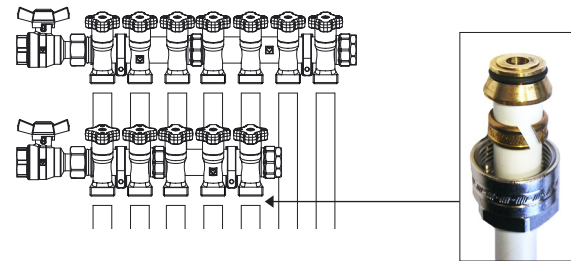

Drinking water systems

Point to point plumbing

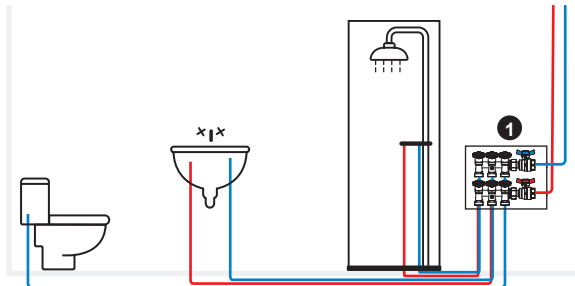

Example of fixture in house

Traditional plumbing

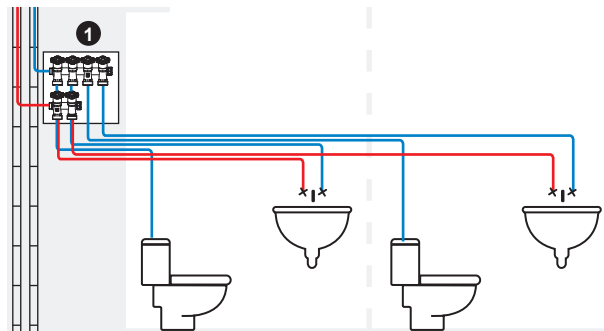
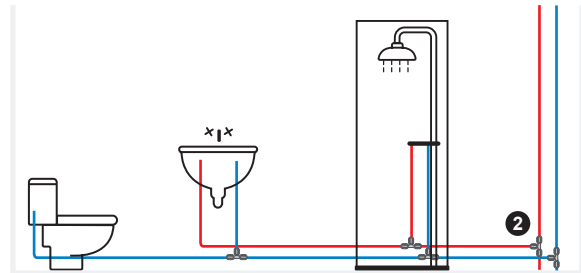

Example of fixture in (apartment) building

1 Manifold

2 Joint

The main advantage of point to point plumbing compared to traditional type of plumbing is the possibility of reducing the number of joints. That way you can decrease the potential risk of leakage.

☑ Assembly instruction

HERZ - Sanitary water manifold systems can be installed directly to the wall using bracket 8422. The mounting position is arbitrary.

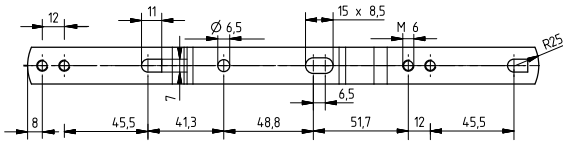
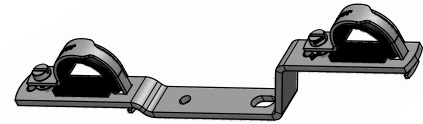
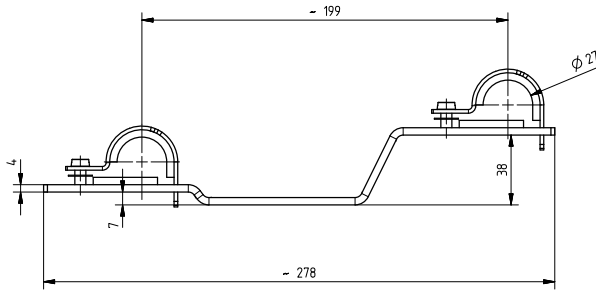

Pipes are screwed onto HERZ Drinking water manifolds. The pipes have to be correctly aligned, so the manifold is not loaded with a bending moment. When using copper or plastic pipes take into account pressure and temperature limits of the selected material. When assembling, use a suitable assembly tool that adapts to manifolds end connections. We recommend you to use HERZ Pipefix G3/4" connection.

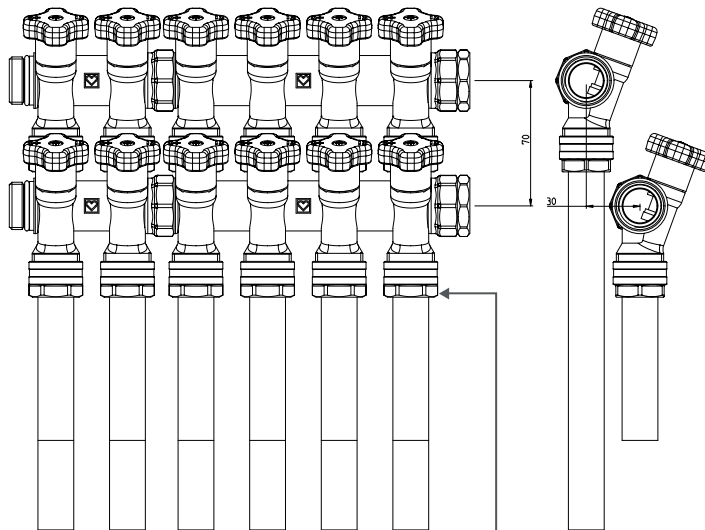

Correctly aligned

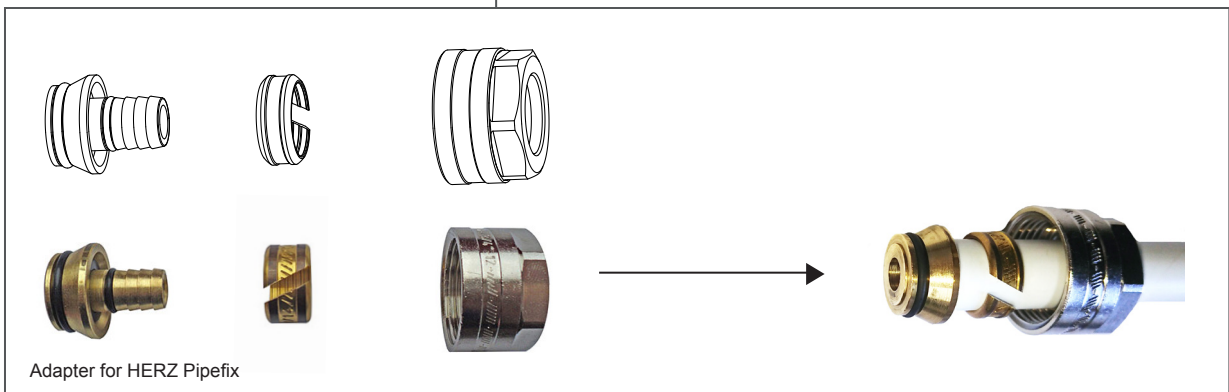

Following assembly, the connections of the manifold must be checked for water-tightness by the installer. All engineering standards and recognized regulations must be adhered to by these specialist staff. If there are impurities in the medium (water too hard, dust, etc.) there should be a filter installed, in other case the impurities can damage the seals of the valves inside the manifold.

Customization

All HERZ sanitary manifolds can be quickly extended with additional manifolds (two, three, four circuits). Pre-installed o-ring sealings are mounted on the housing for easier connection of multiple manifolds. There is no need to add additional sealing or glue. Connecting two housings: fully screw the male thread 3/4" into the female thread. Then unscrew until the handles on the two manifolds align with each other. Before first use we recommend you to use Silicone-based lubricant on the o-ring. HERZ blank plug has to be added at the end of the manifold.

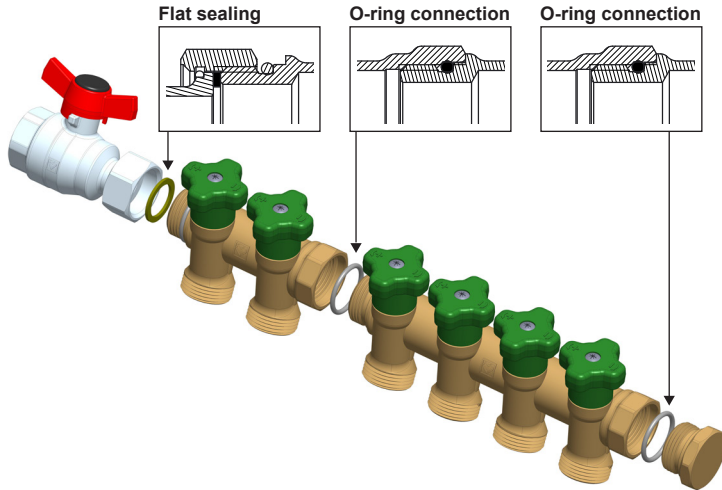

Function principle of components

The factory setting is fully opened. Rotate the handle counter-clockwise or clockwise to adjust the flow (opening/closing).

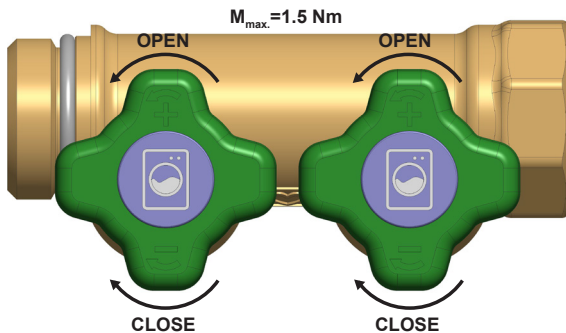

Labelling

Each outlet of sanitary manifolds (e.g. sink, bath, etc.) is identified by applying a small blue or red label with an icon designating the point of use (*labels supplied with product). Use RED labels for hot circuit and BLUE labels for cold circuits.

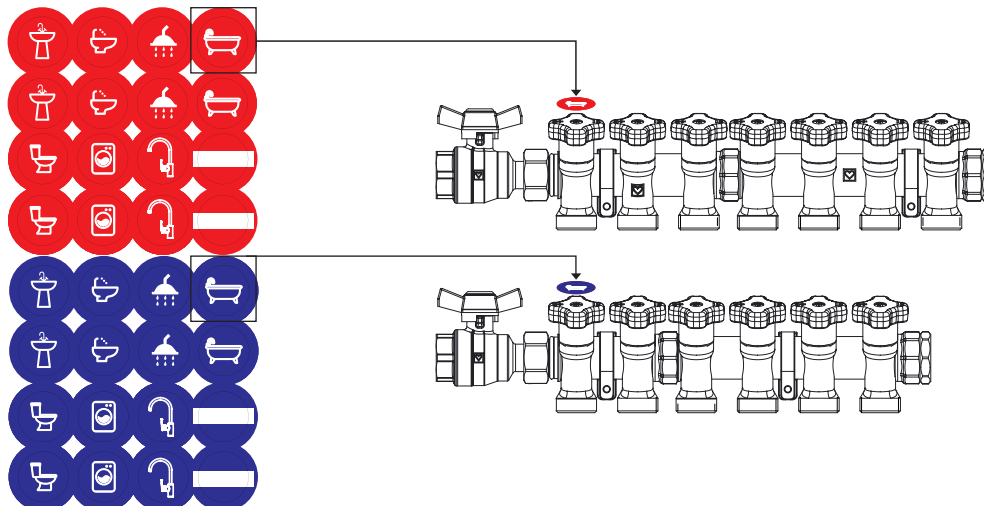

☑ Brass

HERZ uses top-quality brass that is in compliance with the UBA and 4MS lists. Components of HERZ - Drinking water manifolds systems are made from brass due to its good strength and excellent corrosion resistance. Pursuant to Article 33 of the REACH Regulation (EC No. 1907/2006), we are obliged to point out that the material lead is listed on the SVHC list and that all brass components manufactured in our products exceed 0.1% (w / w) lead (CAS: 7439-92-1 / EINECS: 231-100-4). Since lead is a component part of an alloy, actual exposure is not possible and therefore no additional information on safe use is necessary.

☑ Maintenance instruction

The valve does not require any special maintenance. It is mandatory to close and open the valve periodically (at least twice a year, every 6 months). No mineral oil lubricant should be used for the maintenance of the valves. Usage of these materials will damage the sealing elements. Silicone-based lubricant are allowed.

☑ Disposal instruction

The disposal of HERZ - Drinking water manifolds systems must not endanger the health or the environment. National legal regulations for proper disposal of the HERZ - Drinking water manifolds systems have to be followed.

☑ Pressure drop graph

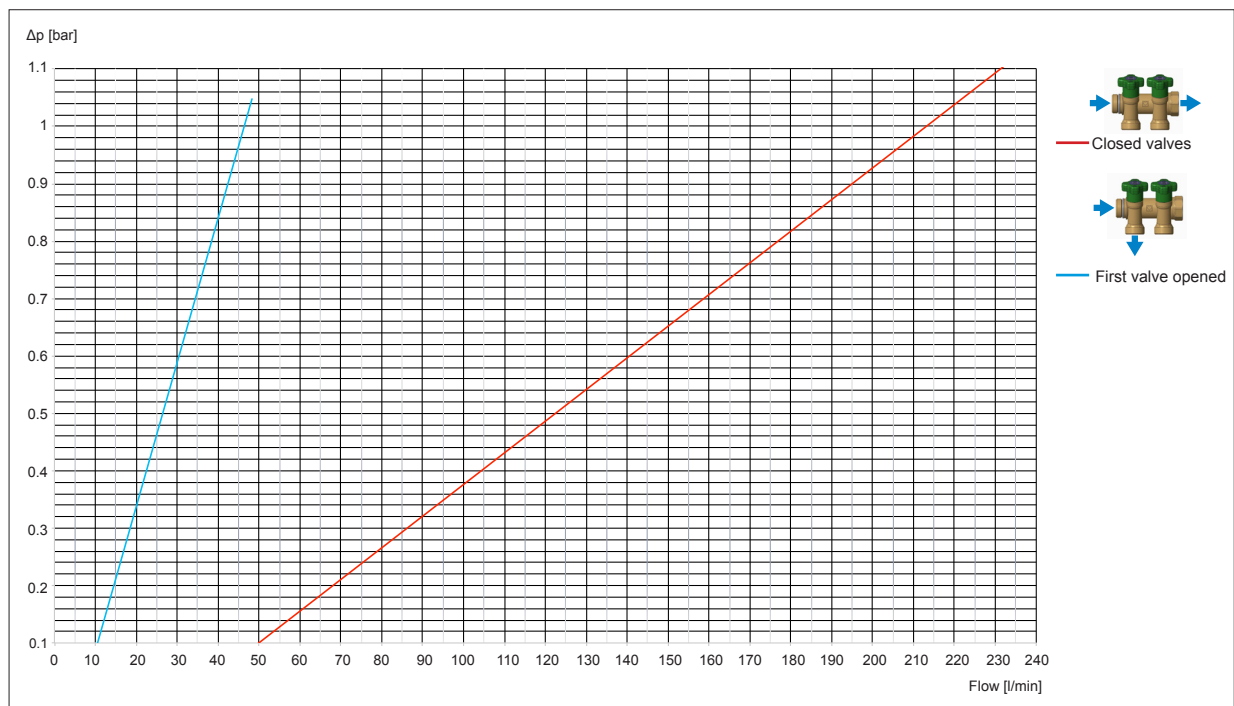



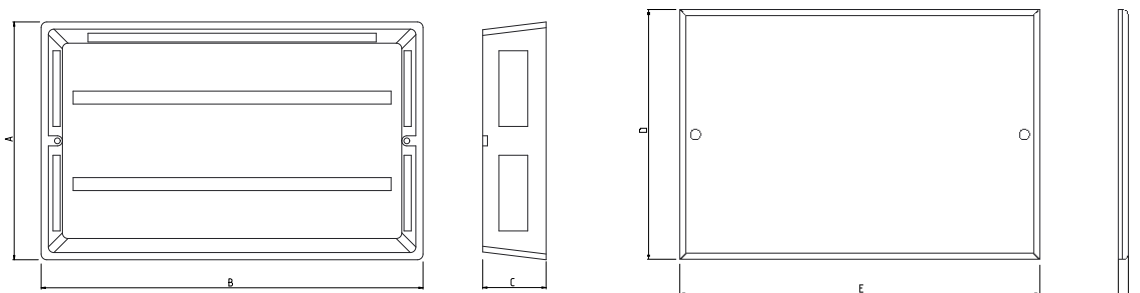

☑ Plastic cabinets

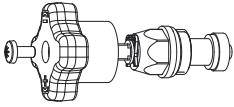

Item number	A [mm]	B [mm]	C [mm]	D [mm]	E [mm]	F [mm]	Width suitable for**
1 6319 24	290	330	88	320	360	10	5 circuits
1 6319 25	310	430	88	320	460	10	8 circuits
1 6319 26	330	530	88	320	560	10	11 circuits

**Minimum size for distributor cabinet. By using shut-off valves the size of distributor cabinet has to be dimensioned larger.

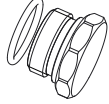
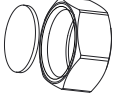
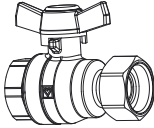
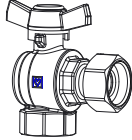
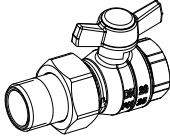
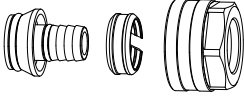
Spare parts:

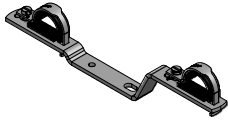
Illustration	Description	Item number
	Handle & spindle	1 6319 20
	O-ring 23 x 2.5	1 6319 21
	Plug G3/4" (*O-ring included)	1 6319 22
	Closing nut G3/4" (*Flat gasket included)	1 6319 23
	Straight ball valve with free moving nut G3/4"	1 2221 02
	Angle ball valve with free moving nut G3/4"	1 2224 22
	Ball valve DN 20	1 2211 12
	Pipefix connectors	Plastic pipe connection 1 6095 01 (G3/4 - 16 x 2) 1 6095 02 (G3/4 - 20 x 2) 1 6095 03 (G3/4 - 26 x 3) 1 6095 04 (G1 - 26 x 3)
	Copper pipe connectors	1 6276 18 (G3/4 - 18)
	Bracket	1 8422 30

All specifications and statements within this document are according to information available at the time of printing and meant for informational purpose only. Herz Armaturen reserves the right to modify and change products as well as its technical specifications and/or its functioning according to technological progress and requirements. It is understood that all images of Herz products are symbolic representations and therefore may visually differ from the actual product. Colours may differ due to printing technology used. In case of any further questions don't hesitate to contact your closest HERZ Branch-office.

Scheme

